

DESCRIPTION

PVC U FENDER

ORDER CODE

**PFU 194**

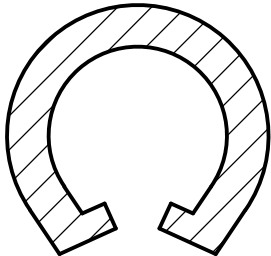

ACTUAL SIZE

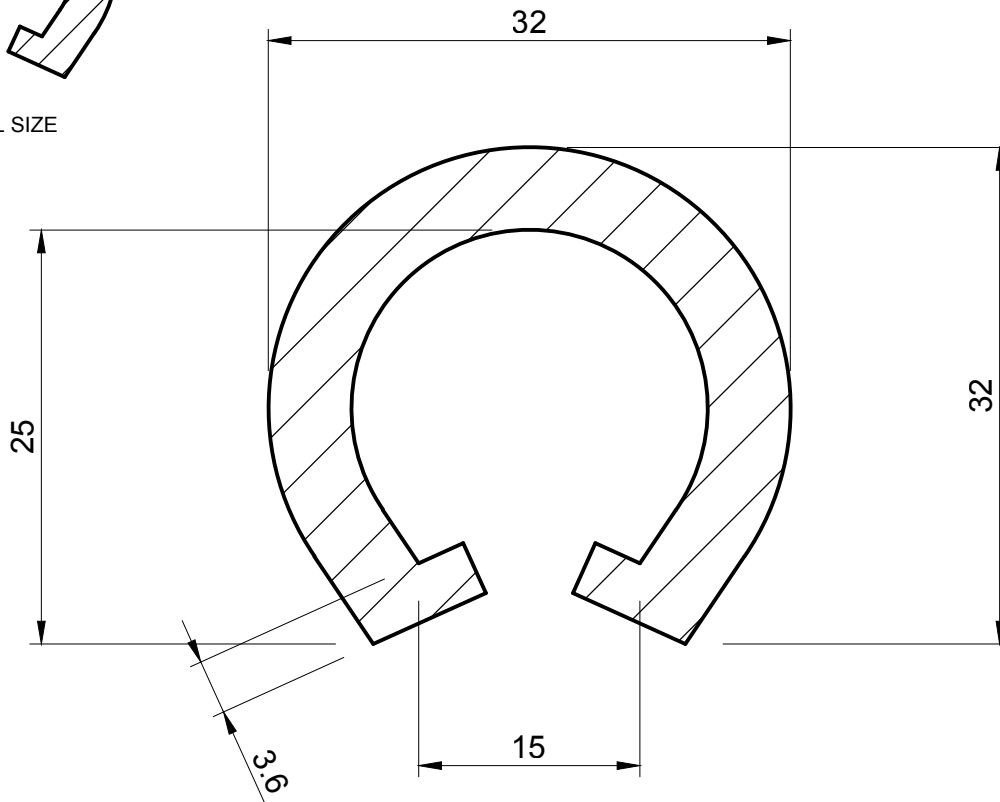

NOTE:

1. SOLD AS A COIL
2. COIL LENGTH 15 METRES
3. WEIGHT 564 GRAMS PER METRE
4. TO FIT A PANEL THICKNESS OF 13.0MM
5. THIS IS A FLEXIBLE COMPONENT THEREFORE OVERALL DIMENSIONS ARE APPROXIMATE

MATERIAL (REFER TO OUR DATA SHEET FOR FULL TECHNICAL DATA)  
**BLACK PVC 84° SHORE A**

TOLERANCE  
**TO BS 3734 CLASS E3**

ISSUE DATE  
**17.03.17**

**Seals + Direct Ltd**

Unit 6, Milton Business Centre, Wick Drive, New Milton, Hants, BH25 6RH  
**Tel: 01425 617722 Fax: 01425 610967 E-mail: sales@sealsplusdirect.co.uk**

Reg. No 4989100

SCALE  
**2 : 1**

PROJECTION



**DIMENSIONS IN MM**

©SEALS + DIRECT LTD

This information and our technical advice, whether verbal, in writing or by way of trials, is given in good faith but without warranty. This also applies where proprietary rights are involved. Our advice does not release you from the obligations to check its validity and to test our products as to their suitability for the intended use. The storage, application and use of our products are beyond our control and, therefore, entirely your own responsibility. Our products are sold in accordance with our General Conditions of Sale. The information contained within this drawing is subject to change without notice.