

SEALS+DIRECT

www.sealsdirect.co.uk

DESCRIPTION

WATERTIGHT DOOR AND HATCH SEAL

ORDER CODE

WDHS 3751

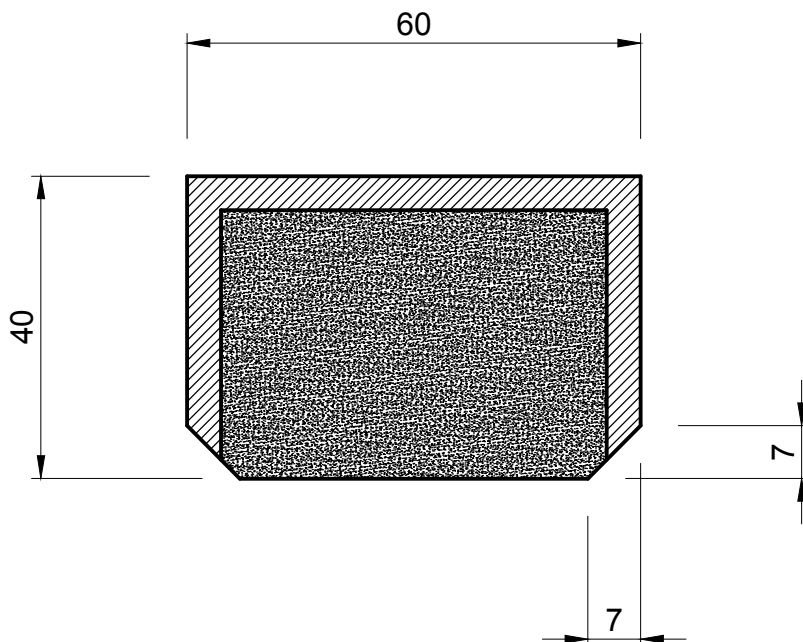

NOTE:

1. SOLD AS A COIL
2. COIL LENGTH 10 METRES
3. WEIGHT 2200 GRAMS PER METRE
4. THIS IS A FLEXIBLE COMPONENT THEREFORE OVERALL DIMENSIONS ARE APPROXIMATE

MATERIAL (REFER TO OUR DATA SHEET FOR FULL TECHNICAL DATA)
NATURAL-SBR & NEOPRENE BLEND OUTER SKIN, NATURAL RUBBER OPEN CELL CORE

TOLERANCE
TO BS 3734 CLASS E3

ISSUE DATE
05.01.17

Seals + Direct Ltd

Unit 6, Milton Business Centre, Wick Drive, New Milton, Hants, BH25 6RH
Tel: 01425 617722 Fax: 01425 610967 E-mail: sales@sealsplusdirect.co.uk

Reg. No 4989100

SCALE
1 : 1

PROJECTION

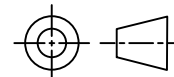

This information and our technical advice, whether verbal, in writing or by way of trials, is given in good faith but without warranty. This also applies where proprietary rights are involved. Our advice does not release you from the obligations to check its validity and to test our products as to their suitability for the intended use. The storage, application and use of our products are beyond our control and, therefore, entirely your own responsibility. Our products are sold in accordance with our General Conditions of Sale. The information contained within this drawing is subject to change without notice.

DIMENSIONS IN MM

©SEALS + DIRECT LTD