

SEALS+DIRECT

www.sealsdirect.co.uk

DESCRIPTION

BROWN TIMBER BUBBLE SEAL

ORDER CODE

TFS 3297



ACTUAL SIZE

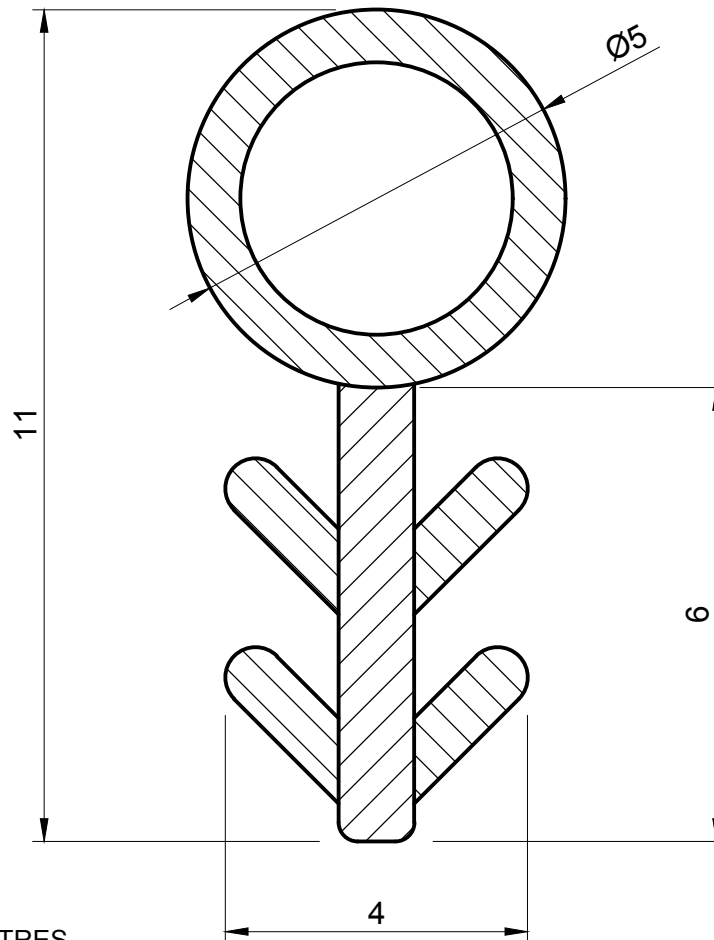

NOTE:

1. SOLD AS A COIL
2. COIL LENGTH 50 METRES
3. WEIGHT 100 GRAMS PER METRE
4. TO FIT A 2.5 - 3.0MM WIDE X 6.0MM DEEP GROOVE
5. TO SEAL A GAP FROM 2.0MM TO 4.5MM
6. THIS IS A FLEXIBLE COMPONENT THEREFORE OVERALL DIMENSIONS ARE APPROXIMATE

MATERIAL (REFER TO OUR DATA SHEET FOR FULL TECHNICAL DATA)
POLYPROPYLENE AND SILPEX (TPE)

TOLERANCE
TO BS 3734 CLASS E2

ISSUE DATE
23.06.16

Seals + Direct Ltd

SCALE
10 : 1

PROJECTION

Unit 6, Milton Business Centre, Wick Drive, New Milton, Hants, BH25 6RH
Tel: 01425 617722 Fax: 01425 610967 E-mail: sales@sealsplusdirect.co.uk

Reg. No 4989100

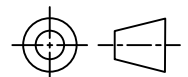

This information and our technical advice, whether verbal, in writing or by way of trials, is given in good faith but without warranty. This also applies where proprietary rights are involved. Our advice does not release you from the obligations to check its validity and to test our products as to their suitability for the intended use. The storage, application and use of our products are beyond our control and, therefore, entirely your own responsibility. Our products are sold in accordance with our General Conditions of Sale. The information contained within this drawing is subject to change without notice.

DIMENSIONS IN MM

©SEALS + DIRECT LTD